

6.1

Proportional pressure relief valve

Type DBET...L5X

NG 6
Up to 350 bar
Up to 2 L/min

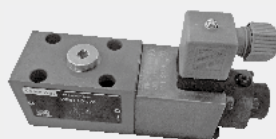

Contents

Function and configuration	02
Ordering code	03
Technical data	03
Electrical	03
Characteristic curves	04-05
Unit dimensions	06

Features

- Direct actuated valve for the limitation of a system pressure
- For subplates: Porting pattern to ISO 4401-03-02-0-05
- 5 pressure stage
- Control electronics for type DBET: Matching electronic amplifier VT-2000 or plug amplifier VT-SSPA1-...-L2X (separate order)

Function and configuration

The type DBET proportional pressure relief valves are remotely controlled valves with poppet valve design and are used to limit the pressure of the system. They are actuated by a proportional solenoid. With these valves, the system pressure to be limited can be set infinitely in relationship to the electrical command value.

These valves mainly consist of the housing (1), a proportional solenoid (2), the valve seat (3) and the valve poppet (4).

The proportional solenoid converts electrical current proportionally into mechanical force. An increase in the current causes a proportionally higher solenoid force. The armature chamber of the solenoid is filled with pressure fluid and is pressure tight.

The setting of the system pressure is carried out command value dependent from the proportional solenoid (2). The solenoid force pushes the valve poppet (4) onto the seat (3). The pressure present in port P of the system acts on the valve poppet (4) and thus against the force of the proportional solenoid. If the hydraulic force on the valve poppet (4) is equal to the solenoid force then the valve controls the set pressure by lifting the valve poppet off the valve seat (3), and thus permitting pressure fluid to flow from P to T. The minimum setting pressure is set with minimum control current related to the zero command value.

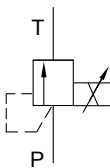
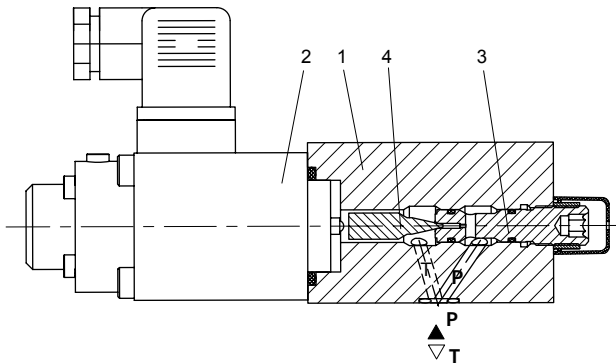

Symbol

Ordering code

DBET	- L5X /	G24	/	*
Proportional pressure relief valve				Further information in plain text
For external control electronics =No code Integrated in the valve =E				For type DBETE : A1= Command/actual value 0 to 10V F1=Command/actual value 4 to 20mA
Series L50 to L59 =L5X (L50 to L59: unchanged installation and connection dimensions)				V = FKM No code = NBR
Up to 50 bar =50 Up to 100 bar =100 Up to 200 bar =200 Up to 315 bar =315 Up to 350 bar =350				For type DBET : K4= Without plug-in connector Z4= With plug-in connector For type DBETE: K31= Without plug-in connector Z31= With plug-in connector
Supply voltage: +24VDC =G24				

Technical data

Pressure fluid		Mineral oils (HL, HLP) to DIN 51 524 Further pressure fluids on request!
Pressure fluid temperature range	°C	-30 to +80 (NBR) -20 to +80 (FKM)
Viscosity range	mm ² /s	15 to 380
Degree of contamination		Maximum permissible degree of fluid contamination: Class 9. NAS 1638 or 20/18/15, ISO4406
Operating pressure (port P)	bar	350
Max. set pressure	bar	50; 100; 200; 315; 350
Min. settable pressure		see characteristic curves
Min. settable pressure at 0 command value		=Min. settable pressure
Return pressure (port T)	bar	Separate and at zero pressure to tank
Max.Flow	L/min	2
Linearity		± 3.5 % of max. settable pressure
Hysteresis (See setting pressure characteristic curve)		± 1.5 % of max. settable pressure
Repeatability		< ± 2 % of max. settable pressure
Switching time	ms	30 bis 150 (system dependent)

Electrical data

Supply voltage		24V DC
Min. control current	mA	100
Max. control current	mA	800
Coil resistance		5.5Ω Cold value at 20°C ; Max. warm value: 8.05Ω
Duty		Continuous
Electrical connections		Plug-in connector to DIN EN 175301-803/ISO 4400
Valve protection to DIN 40 050		IP 65
Amplifier		VT-2000 or VT-SSPA1-....L2X

Characteristic curves (measured with HLP46, $\vartheta_{oil}=40^{\circ}\text{C} \pm 5^{\circ}\text{C}$)

• Pressure in port P in relation to the command value ($q_v=0.8\text{ L/min}$)

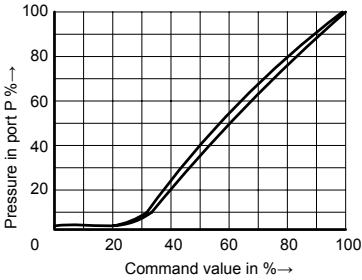

• Pressure in port P in relation to the flow

Pressure stage 50 bar

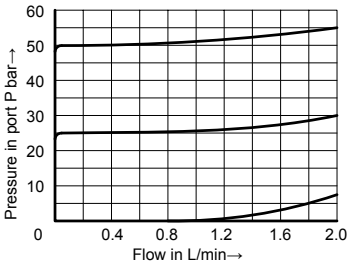

Pressure stage 100 bar

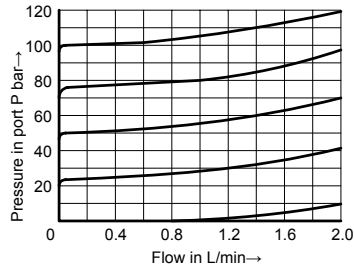

Pressure stage 200 bar

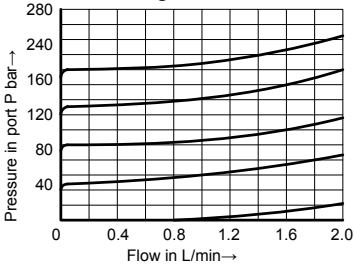

Pressure stage 315 bar

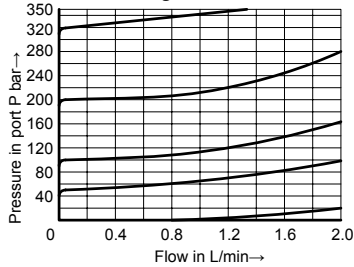

Pressure stage 350 bar

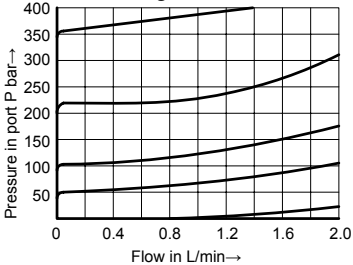

Characteristic curves (measured with HLP46, $\vartheta_{oil} = 40^\circ\text{C} \pm 5^\circ\text{C}$)

- Min. settable pressure in port P with command value 0

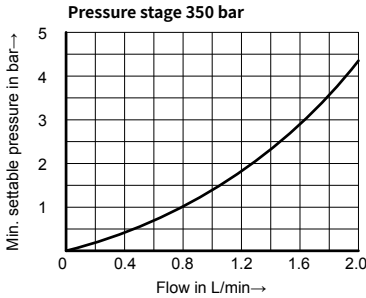
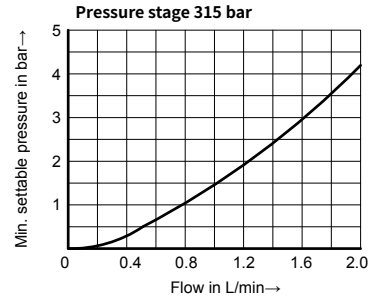
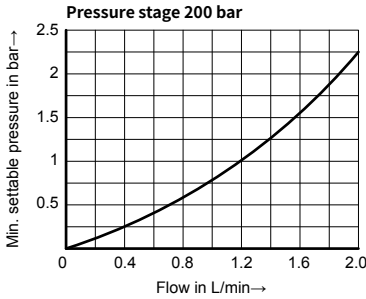
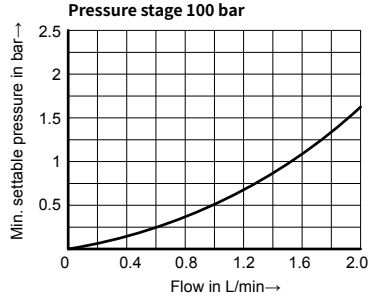
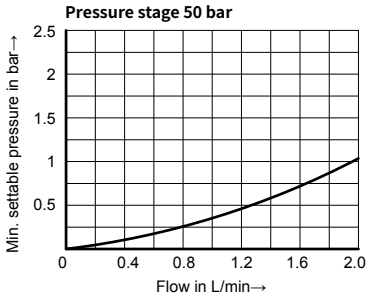

Unit dimensions

(Dimensions in mm)

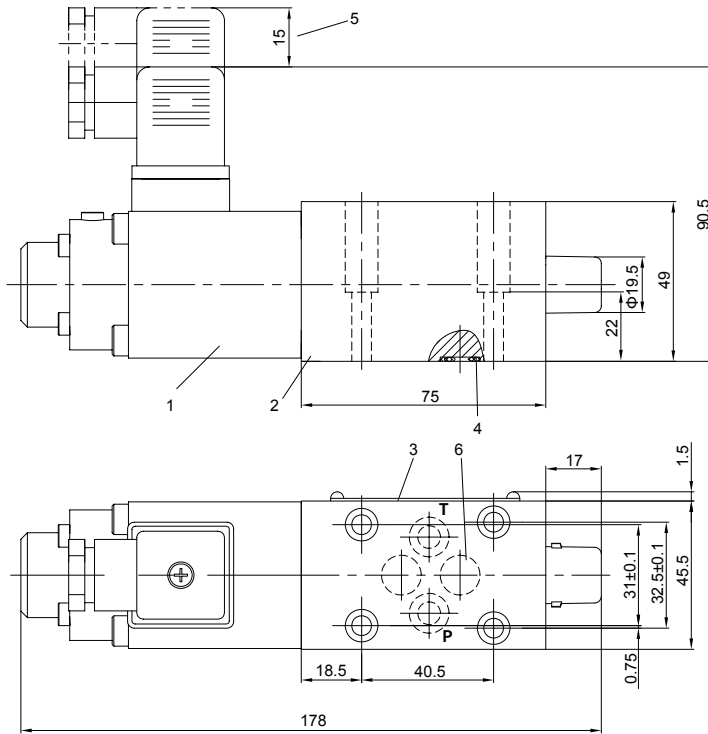

- 1 Proportional solenoid
- 2 Valve housing
- 3 Name plate
- 4 R-rings 9.81×1.5×1.78
- 5 Space required to remove the plug-in connector
- 6 Blind counter bore

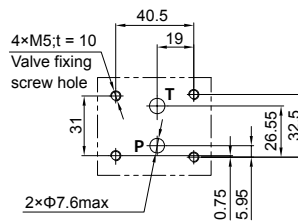
**Valve fixing screws:**

4-M5×30 GB/T 70.1-10.9;

Tightening torque, $M_A = 8.9 \text{ Nm}$ 