



4/3, 4/2 and 3/2 directional valve with mechanical, manual operation

2.1

Type WMD6...L6X

Size 6
Up to 315 bar
Up to 60L/min



Contents

Function and configuration	02
Ordering code	02
Symbols	03
Technical data	03
Characteristic curves	04
Operating limitation	04
Unit dimensions	05

Features

- Direct operated directional spool valve
- Sub-plate mounting
- Rotary knob with or without lock
- 45 versions standard spool
- Porting pattern confirms to DIN 24 340 form A and ISO 4401

Function and configurations

Directional valves type WMD... are mechanical, manual operated directional spool valves. They control the start, stop and direction of a flow.

The rotary knob (2) operates ($2 \times 90^\circ$) the spool (1), the screw type rotation transforms into axial movement and direct acts on the spool (1). Then the spool (1) moves to the end position and gets the opening position as required.

Actual switch position of spool (1) can be controlled with rotary knob (2). All the switch

positions can be orientated by locating device.

Throttle

The use of a throttle insert is required, when, operating, flows can occur during the switching processes that exceed the performance limit of the valve.

These throttles are to be inserted into the P-channel of the directional valve.

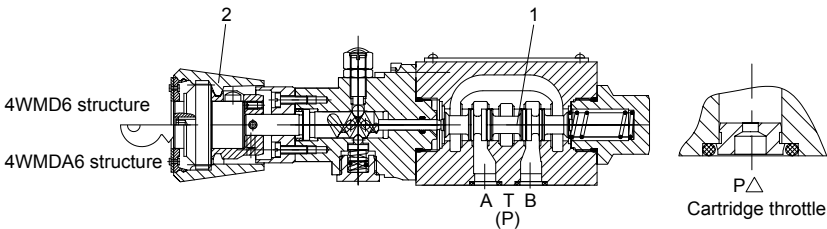

Ordering code

	WMD	6	-L6X / F		*
3 ways(version A)	=3				Further details in clear text
4 ways	=4				
Rotary knob					No code = NBR seals V = FKM seals
Without lock	=No code				No code = Without cartridge throttle
With lock	= A				B08 = Throttle - $\Phi 0.8$ mm B10 = Throttle - $\Phi 1.0$ mm B12 = Throttle - $\Phi 1.2$ mm
Nominal size 6	=6				F = With detent
Symbols e.g. C, E, EA, EB etc. see below					
Series L60 to L69 (L60 to L69:unchanged installation and connection dimensions)			=L6X		

Symbols

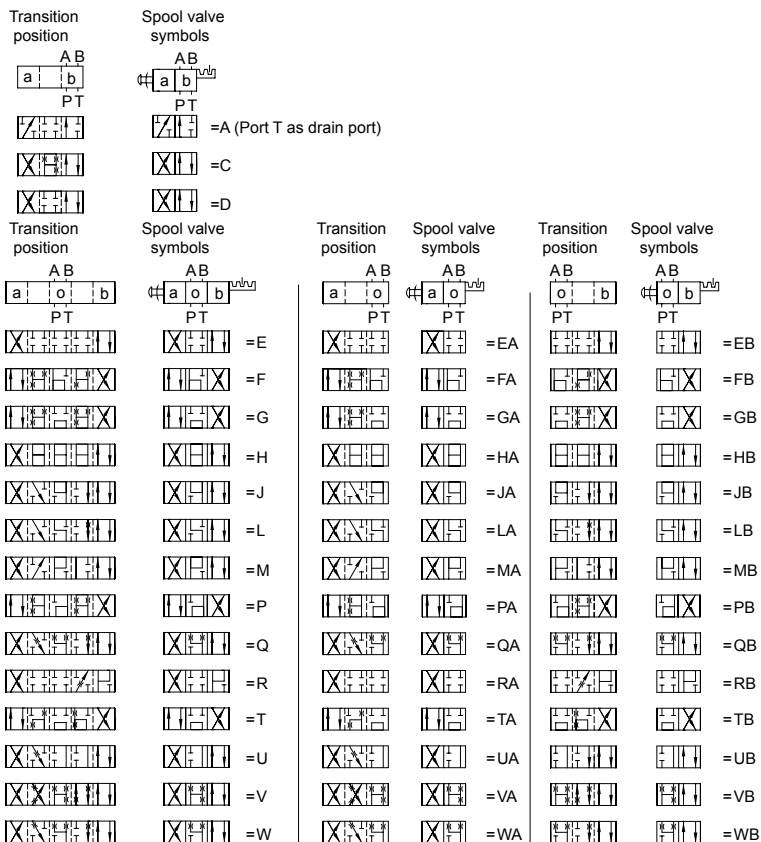

02

Technical data

Fluid temperature range	°C	-30 to +80 (NBR seal) -20 to +80 (FKM seal)
Max. operating pressure	Port A,B,P	bar 315
	Port T	bar 160
Max. flow-rate	L/min	60
Flow cross section (switching neutral position)	Type Q	mm ² for symbol Q 6% of nominal cross section
	Type W	mm ² for symbol W 3% of nominal cross section
Fluid		Mineral oil, Phosphate ester
Viscosity range	mm ² /s	2.8 to 500
Degree of contamination		Maximum permissible degree of fluid contamination: Class 9. NAS 1638 or 20/18/15, ISO4406
Weight	kg	1.5

Characteristic curves (Measured at $\vartheta_{oil}=40^{\circ}C \pm 5^{\circ}C$, using HLP46)

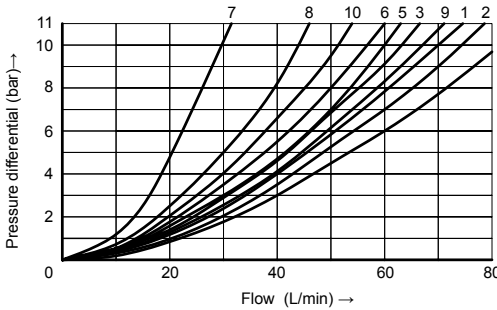

- 7 Symbol "R" in switched positions B → A
- 8 Symbol "G" and "T" in neutral position P → T
- 9 Symbol "H" in neutral position P → T

Spool symbols	Flow direction			
	P to A	P to B	A to T	B to T
AB	3	3	-	-
C	1	1	3	1
DY	5	5	3	3
E	3	3	1	1
F	1	3	1	1
T	10	10	9	9
H	2	4	2	2
JQ	1	1	2	1
L	3	3	4	9
M	2	4	3	3
P	3	1	1	1
R	5	5	4	-
V	1	2	1	1
W	1	1	2	2
U	3	3	9	4
G	6	6	9	9

Operating limitations

The switching performance of the valves depends on the filtration. In order to achieve the specified admissible flow values, we recommend full flow filtration with 25 µm. The flow forces acting within the valves also affect the flow performance. With 4 way valves the specified flow data thus apply to normal operation with 2 volume flow directions (e.g. from P to A and at the same time return flow from B to T) (see table).

If only one flow direction is available, in certain cases, the admissible flow can be significantly smaller (e.g. when using a 4 way valve as 3 way valve, due to blocked connection A or B).

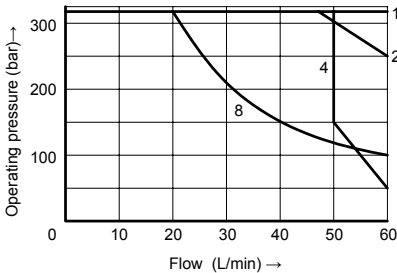

Curve	Spool symbol
1	E, M, H, C, D, Y, Q, U, W
2	J, L
4	G, P
8	T

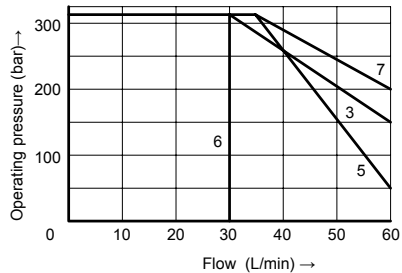

Curve	Spool symbol
3	A, B
5	F
6	V
7	R

Unit dimensions

(Dimensions in mm)

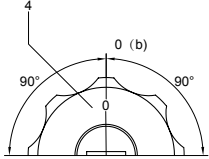
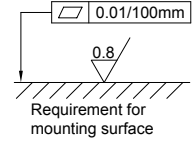
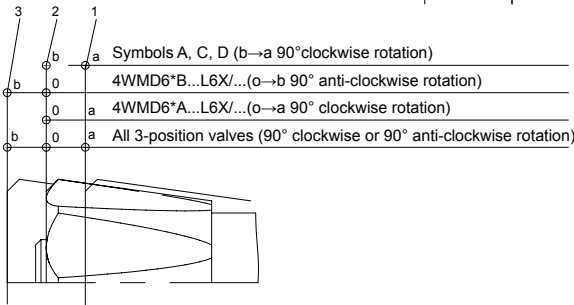
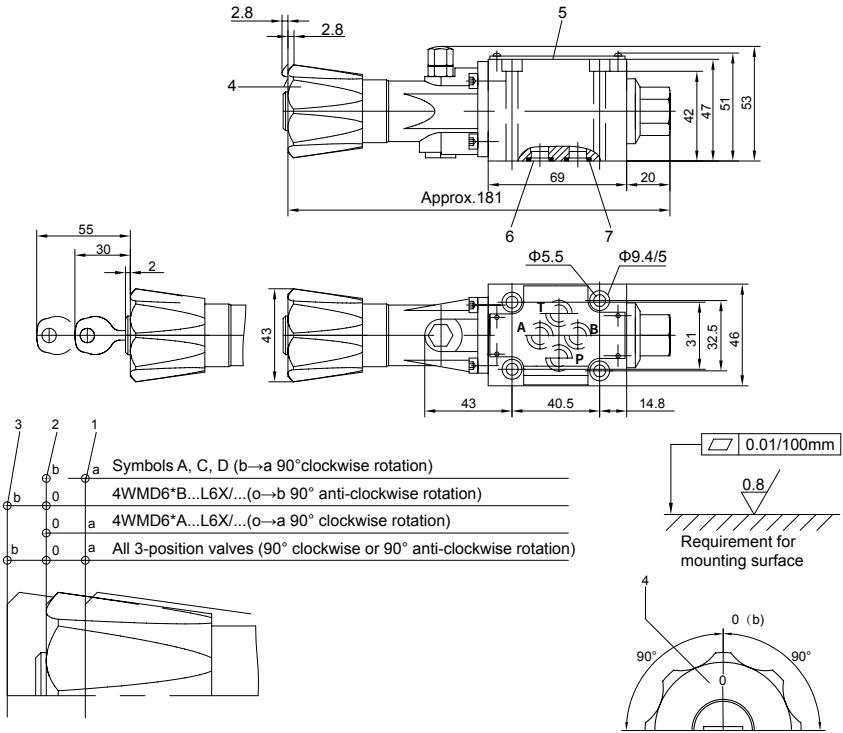

- 1 Switched position b → a, o → a
- 2 Switched position a → b, a → o, b → o
- 3 Switched position o → b
- 4 3-position valve (including spool *A and *B):
Switched position b
Operating valve 90° clockwise and 90° anti-clockwise
- 5 Nameplate
- 6 Fixing surface
- 7 O-ring 9.25 × 1.78 for ports A, B, P and T

Valve fixing screws:

Internal hexagon screw
M5 × 50 GB/T 70.1-10.9
Tightening torque $M_A = 9\text{Nm}$
must be ordered separately

It must be ordered separately, if connection plate is needed.

- Type:** G 341/01 (G 1/4), G 341/02 (M14 × 1.5)
G 342/01 (G 3/8), G 342/02 (M18 × 1.5)
G 502/01 (G 1/2), G 502/02 (M22 × 1.5)

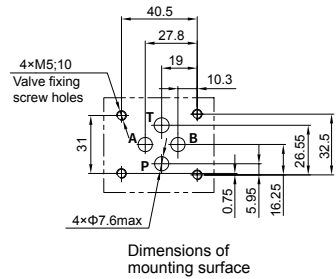

China

+86 400 101 8889

America

+01 630 995 3674

Germany

+49 172 3683463

Japan

+81 03 6809 1696



© This brochure can be reproduced, edited, reproduced or transmitted electronically without the authorization of Hengli Hydraulic Company. Due to the continuous development of the product, the information in this brochure is not specific to the specific conditions or applicability of the industry, thus, Hengli does not take any responsibility for any incomplete or inaccurate description.



4/3, 4/2 and 3/2 directional valve with mechanical, manual operation

2.2

Type WMD10...L3X

Size 10
Up to 315 bar
Up to 120L/min

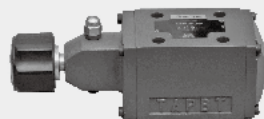

Contents

Function and configuration	02
Ordering code	02
Symbols	03
Technical data	03
Characteristic curves	04
Operating limitation	04
Unit dimensions	05

Features

- Direct operated directional spool valves with mechanical, manual operation
- For sub-plates mounting
- Rotary knob with or without lock
- 45 kinds standard spools, optional
- Porting pattern confirms to DIN 24 340 form A and ISO 4401

Function and configurations

Directional valves type WMD... are mechanical, manual operated directional spool valves. They control the start, stop and direction of a flow.

The rotary knob (2) operates ($2 \times 90^\circ$) the spool(1), the screw type rotation transforms into axial movement and direct acts on the spool(1). Then the spool (1) moves to the end position and gets the opening position as required.

Actual switch position of spool (1) can be controlled with rotary knob (2). All the switch positions can be orientated by locating device.

Cartridge throttle

The use of a throttle insert is required, when operating, flows can occur during the switching processes that exceed the performance limit of the valve.

These throttles are to be inserted into the P-channel of the directional valve.

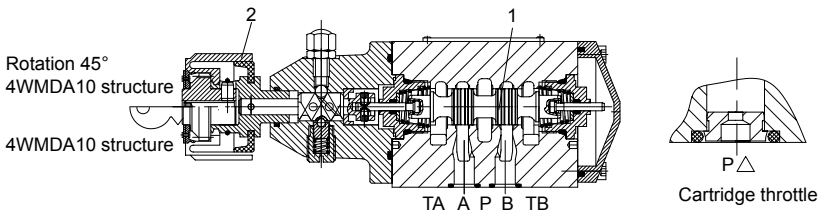

Ordering code

	WMD	10	L3X / F	*
3 ways(version A) =3 4 ways =4				Further details in clear text
Rotary knob				No code = NBR seals V = FKM seals
Without lock =No code With lock = A				No code = Without cartridge throttle B08 = Throttle - $\Phi 0.8$ mm B10 = Throttle - $\Phi 1.0$ mm B12 = Throttle - $\Phi 1.2$ mm
Nominal size 10 =10				F = With detent
Symbols e.g. C, E, EA, EB etc. see below				
Series L30 to L39 (L30 to L39: unchanged installation and connection dimensions)			=L3X	

Symbols

<p>Transition position</p> <p>AB</p> <p>PT</p>	<p>Spool valve symbols</p> <p>AB</p> <p>PT</p> <p>=A (Port T as drain port)</p> <p>=C</p> <p>=D</p>	<p>Transition position</p> <p>AB</p> <p>PT</p>	<p>Spool valve symbols</p> <p>AB</p> <p>PT</p> <p>=EA</p> <p>=FA</p> <p>=GA</p> <p>=HA</p> <p>=JA</p> <p>=LA</p> <p>=MA</p> <p>=PA</p> <p>=QA</p> <p>=RA</p> <p>=UA</p> <p>=VA</p> <p>=WA</p>	<p>Transition position</p> <p>AB</p> <p>PT</p>	<p>Spool valve symbols</p> <p>AB</p> <p>PT</p> <p>=EB</p> <p>=FB</p> <p>=GB</p> <p>=HB</p> <p>=JB</p> <p>=LB</p> <p>=MB</p> <p>=PB</p> <p>=QB</p> <p>=RB</p> <p>=UB</p> <p>=VB</p> <p>=WB</p>
--	---	--	---	--	---

Technical data

Fluid temperature range	°C	-30 to +80 (NBR seal) -20 to +80 (FKM seal)
Max. operating pressure	Port A,B,P	bar 315
	Port T	bar 160
Max. flow-rate	L/min	120
Flow cross section (switching neutral position)	Type V	mm ² for symbol V 11(A/B to T) 10.3(P to A/B)
	Type W	mm ² for symbol W 2.5(A/B to T)
	Type Q	mm ² for symbol Q 5.5(A/B to T)
Fluid		Mineral oil, Phosphate ester
Viscosity range	mm ² /s	2.8 to 500
Degree of contamination		Maximum permissible degree of fluid contamination: Class 9. NAS 1638 or 20/18/15, ISO4406
Weight	kg	4.2

Characteristic curves (Measured at $\vartheta_{oil} = 40^{\circ}\text{C} \pm 5^{\circ}\text{C}$, using HLP46)

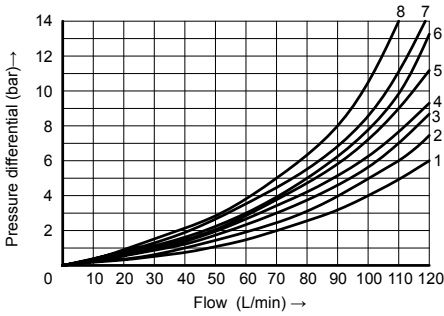

8 Symbols "G" and "T" in mid position (P → T)
 8 Symbol "R" in position b (A → B)

Spool symbol	Flow direction			
	P to A	P to B	A to T	B to T
A	4	3	-	-
B	3	4	-	-
C	3	3	4	4
D	3	3	5	5
E	2	2	4	4
F	1	2	3	4
G,T	4	4	7	7
H	1	1	5	5
J	2	2	3	3
L	3	3	2	4
M	1	1	4	4
P	3	1	5	5
Q	2	2	2	2
R	3	4	3	-
U	3	3	5	2
V	2	2	3	3
W	3	3	3	3
Y	4	4	6	6

Operating limitation

The switching performance of the valves depends on the filtration. In order to achieve the specified admissible flow values, we recommend full flow filtration with 25 μm. The flow forces acting within the valves also affect the flow performance. With 4 way valves the specified flow data thus apply to normal operation with 2 volume flow directions (e.g. from P to A and at the same time return flow from B to T) (see table).

If only one flow direction is available, in certain cases, the admissible flow can be significantly smaller (e.g. when using a 4 way valve as 3 way valve, due to blocked connection A or B).

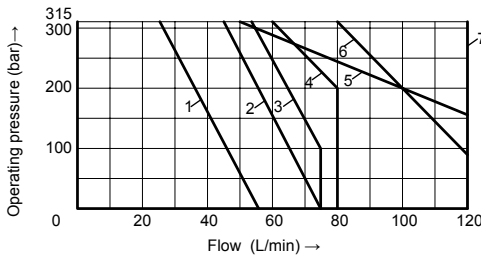

Curve	Spool symbols
1	A,B
2	A/O
3	H
4	F,G,P,R,T
5	J,L,Q,U,W
6	C,D,E,M,Y,Y
7	C/O,C/OF D/O,D/OF

Unit dimensions

(Dimensions in mm)

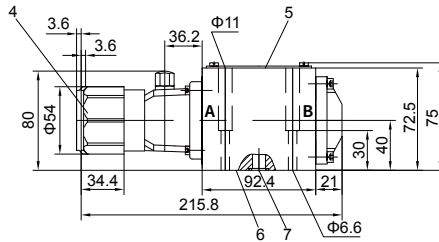
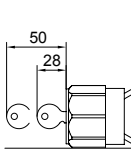

Valve fixing screws:

Internal hexagon screw
M6×40 GB/T 70.1-10.9

Tightening torque

$M_A = 15.5 \text{ Nm}$

must be ordered separately

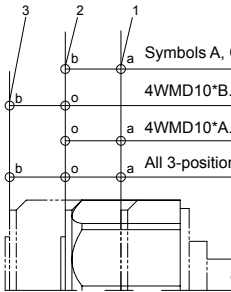
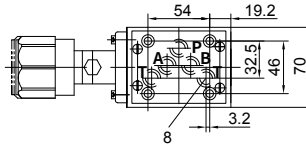

Symbols A, C, D (b→a 90° clockwise rotation)

4WMD10*B...L6X/...(o→b 90° anti-clockwise rotation)

4WMD10*A...L6X/...(o→a 90° clockwise rotation)

All 3-position valves (90° clockwise or 90° anti-clockwise rotation)

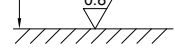
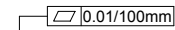

Requirement for mounting surface

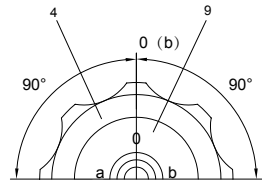

- 1 Switched position b → a, o → a
- 2 Switched position a → b, a → o, b → o
- 3 Switched position o → b
- 4 3-position valve (including spool *A and *B):
Switched position b
Operating valve 90° clockwise and 90° anti-clockwise
- 2-position valve (spool A, C, D): Operating valve 90° clockwise
- 5 Nameplate
- 6 Fixing surface
- 7 O-ring 12×2 for ports A, B, P and T
- 8 Additional return port when using control block
- 9 Observe the spool position through the colorful disc in the front of the rotary knob

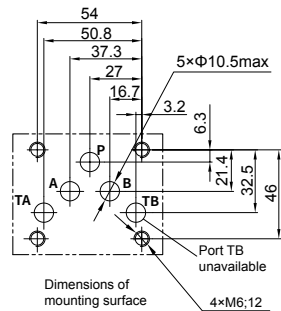

It must be ordered separately if connection plate is needed.

Type:

- G 66/01 (G 3/8), G 66/02 (M18×1.5)
- G 67/01 (G 1/2), G 67/02 (M22×1.5)
- G 534/01 (G 3/4), G 534/02 (M27×2)

China

+86 400 101 8889

America

+01 630 995 3674

Germany

+49 172 3683463

Japan

+81 03 6809 1696



© This brochure can be reproduced, edited, reproduced or transmitted electronically without the authorization of Hengli Hydraulic Company. Due to the continuous development of the product, the information in this brochure is not specific to the specific conditions or applicability of the industry, thus, Hengli does not take any responsibility for any incomplete or inaccurate description.